

TFD Array Modification: Dual Two Element Vertical Stacked Yagi

Larry Dodd

K4LED Observatory

101science@gmail.com

(October 29, 2017)

Abstract

Two reflector elements were added to the existing Typinski Dual TFD Linear Array at the K4LED Observatory. The purpose is to investigate the added gain and improved front to back ratio in an effort to reduce received RFI. Preliminary results look favorable for significant rear and side received RFI reduction. Empirical Jupiter antenna signal strength gain measurements await the next Jupiter season.

Keywords: antennas, design, research, RFI, radiation theory, TFD, Yagi-Uda, gain

Introduction:

Antenna gain can be obtained from a compromise of other antenna parameters. In this case increasing the front to back ratio for a reduction of radiation reception off the back and sides of the antenna and a slight narrowing of beam-width is the source of an increased forward gain.

Methods:

Configure the existing Typinski Dual TFD Array at the K4LED Observatory as a 2 element yagi antenna in a dual vertical stacked array by adding a parasitic reflector element to each TFD. A driven element to reflector spacing optimization derived from Yagi formulas was incorporated to minimize adverse effects on antenna impedance and bandwidth. A combination of theoretical calculation, software modeling, and empirical testing are utilized in the planning, design, construction and testing of the experiment. We will proceed then with the sequence of plan, design, analyze, modify, construct, test, compromise, and adjust then repeat those steps as needed. (Note: We will call this modified antenna a Yagi in this paper although its broad bandwidth nature is not a normal Yagi characteristic.)

Design Goal:

A significant reduction in rear and side received RFI and improved forward signal strength is the object of this experiment. At the same time we design in an effort to minimize degradation of the initial TFD array.

Discussion: Theory, Analysis, and Experimental Procedures.

The existing wide band (15 to 30 MHz) Typinski TFD dual driven elements (DE) were modified into a vertical stacked two element Yagi-Uda configuration by adding rear parasitic reflectors. Elements are E-W aligned with the south element ~ 3 feet below and 20 feet in front of the North element. DE to reflector spacing is optimized to eliminate detrimental degradation to array bandwidth and impedance. An insignificant horizontal beam-width reduction is due to the stacked and forward shifted Yagi array. It is minimized by the fact that the stacked array is separated horizontally and lower and in front of the DE rather than directly above and below one another as found in a normal Yagi stacked array. The theoretical gain and beam-width can be modeled with software based on previously derived formulas. See Figure 1 sample below from an article in the August 1981 QST by Doug DeMaw, W1FB. This simple modeling does not consider varying terrain and other anomalies. The optimistic plot in figure 2 shows elevation in green and azimuth in red. Elevation angle: 40° to 60° with peak at 41° and a F/B ratio of 7.7 dB. Maximum forward gain of 10.4 dBi.

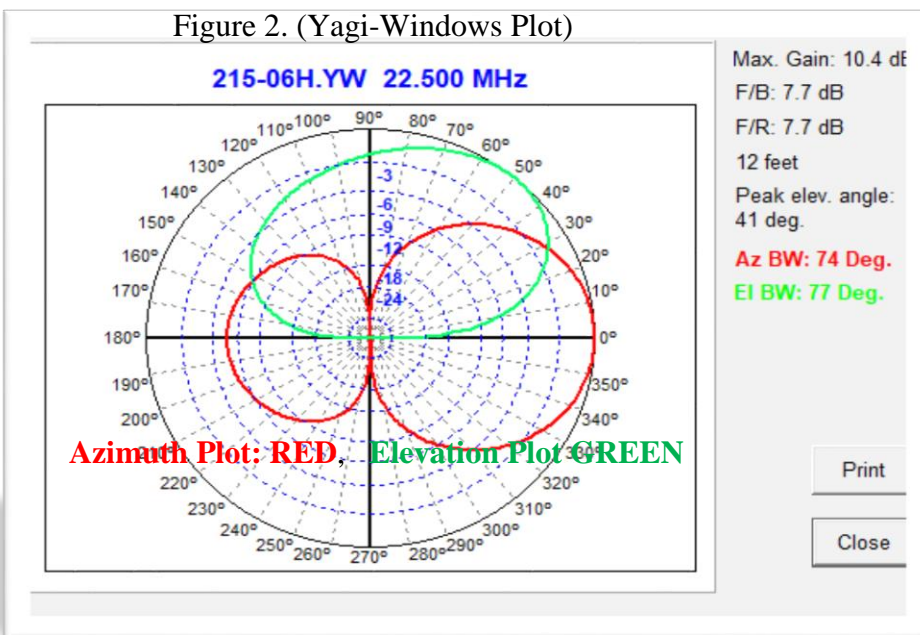
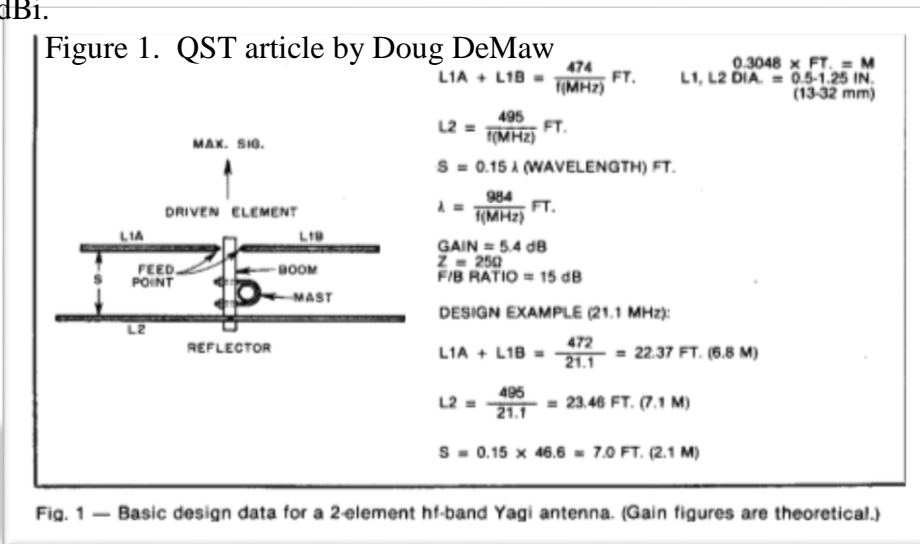

Actual gain and beam-width to be determined in actual use and measured over time. Many environmental effects of near-by structures, height of the elements, ground condition consideration, etc. will affect the theoretical model performance of the array in real world actual use. In our specific case the terrain will play a significant factor in the difference between a theoretical model and actual performance. Utilization of High Frequency Terrain Assessment (HFTA) software along with MicroDEM is useful for determining effects of local terrain. (See Appendix 2) Benefits of the stacked Yagi include improved front to back ratio, less back and side lobe RFI, and a realistic forward gain guesstimate at 3 dB above the TFD array alone. Benefits of the array on a dry slope includes reduction of element to ground interaction as opposed to other configurations. Lower element height is less detrimental since the ground is dry rocky clay and not a great reflector of RF. Empirical gain and beam-width measurements will require actual Jupiter reception. The delay line is still necessary to compensate for the forward position of the southern elements and for maximizing reception from the desired elevation beam angle. Increased height decreases the launch angle. Decreased height increases launch angle. The lower height helps to reduce unwanted long distance low angle HF radio signal reception. For our Jupiter radio astronomy purposes launch angles will vary depending on the actual location of Jupiter at any given point in time.

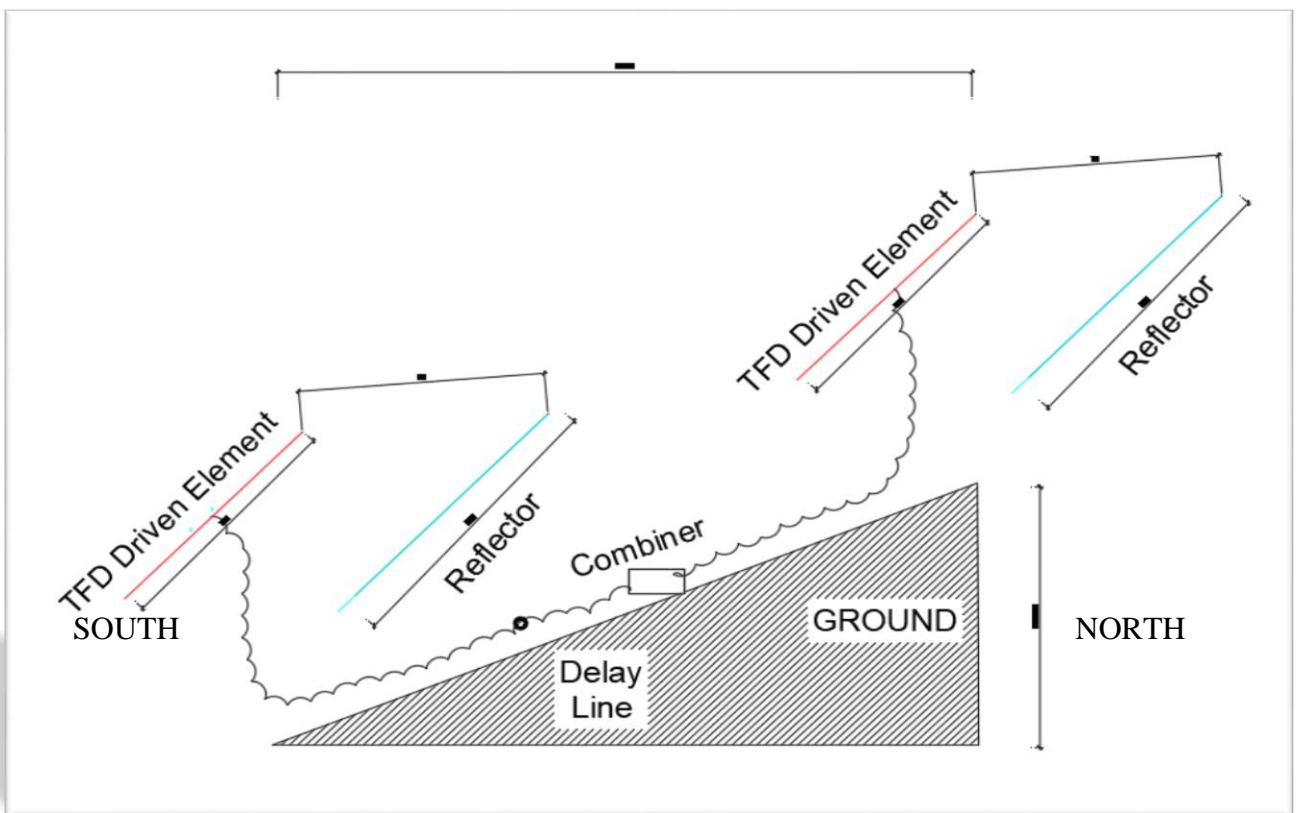

A significant reduction in rear and side RFI is noticed. (See RSP samples below.)

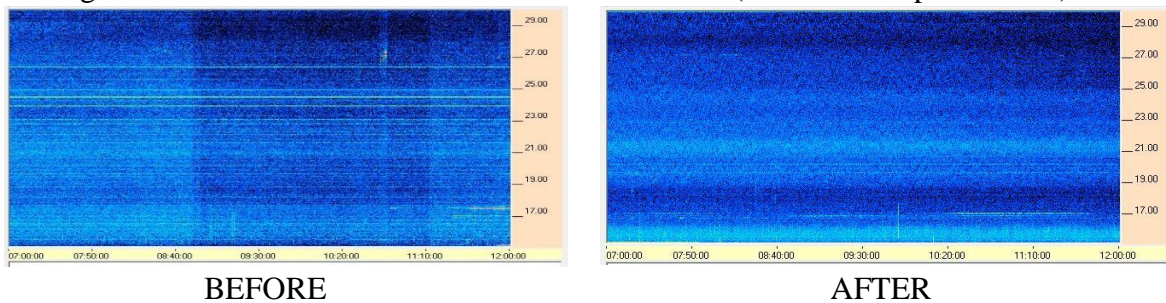

This is not perfect but any reduction is warmly welcomed. Further adjustment of the reflectors position and length will be part of the on-going long term experimentation. VSWR measurements were taken prior to the modification and afterward. In both cases VSWR was well below 1.5:1 from 15 to 30 MHz. This confirms a positive result of our design goal of restricting degradation of the Typinski designed TFD antenna array impedance. The actual gain advantage of the dual TFD 2 element Yagi stacked array in collecting Jupiter data will be measured once the Jupiter observation season returns. (See Appendix 3 for additional VSWR data.)

Acknowledgments: I wish to thank Dave Typinski, for his expertise, suggestions and encouragement to conduct this experiment and to Dick Flagg for his tireless mentoring and instruction and to all the Radio Jove staff and membership for their cooperation and assistance. I also acknowledge my debt to the authors of the references cited below.

References:

Yagi-Uda antenna, Wikipedia, https://en.wikipedia.org/wiki/Yagi-Uda_antenna
2 Element Yagi, by Keith WB2VUO, www.hamuniverse.com/wb2vuo2elyagi.html
HFTA and MicroDEM, Dean Straw N6BV, and K6TU.net; John White, Feb. 2014
QST, August 1981, Doug DeMaw - Yagi
How High should my Dipole be? by Banz, AA3RL, <http://www.qsl.net/aa3rl/ant2.htm>
Antenna Physics, Zavrel, W7SX, ARRL Inc., 2017
ARRL Antenna Handbook 2018, Gallagher, NY2RF, ARRL Inc.
Antennas, Kraus, McGraw-Hill College; Subsequent edition (March 1, 1988)
SUG Antennas – Modeled Element and Array Response Comparison, Typinski, Nov. 2015
Listening To Jupiter, A Guide for the Amateur Radio Astronomer, Flagg, 2000, 2005
Yagi Windows, Software, Dean Straw N6BV, 2015
SWR for the HF Radio Astronomer, Typinski and Flagg, August, 2012

Appendix:

1. Typinski Dual TFD Array Modification: Dual Two Element Vertical Stacked Yagi; design basic layout drawing. (October 29, 2017)
2. High Frequency Terrain Assessment at K4LED Observatory
3. VSWR Data

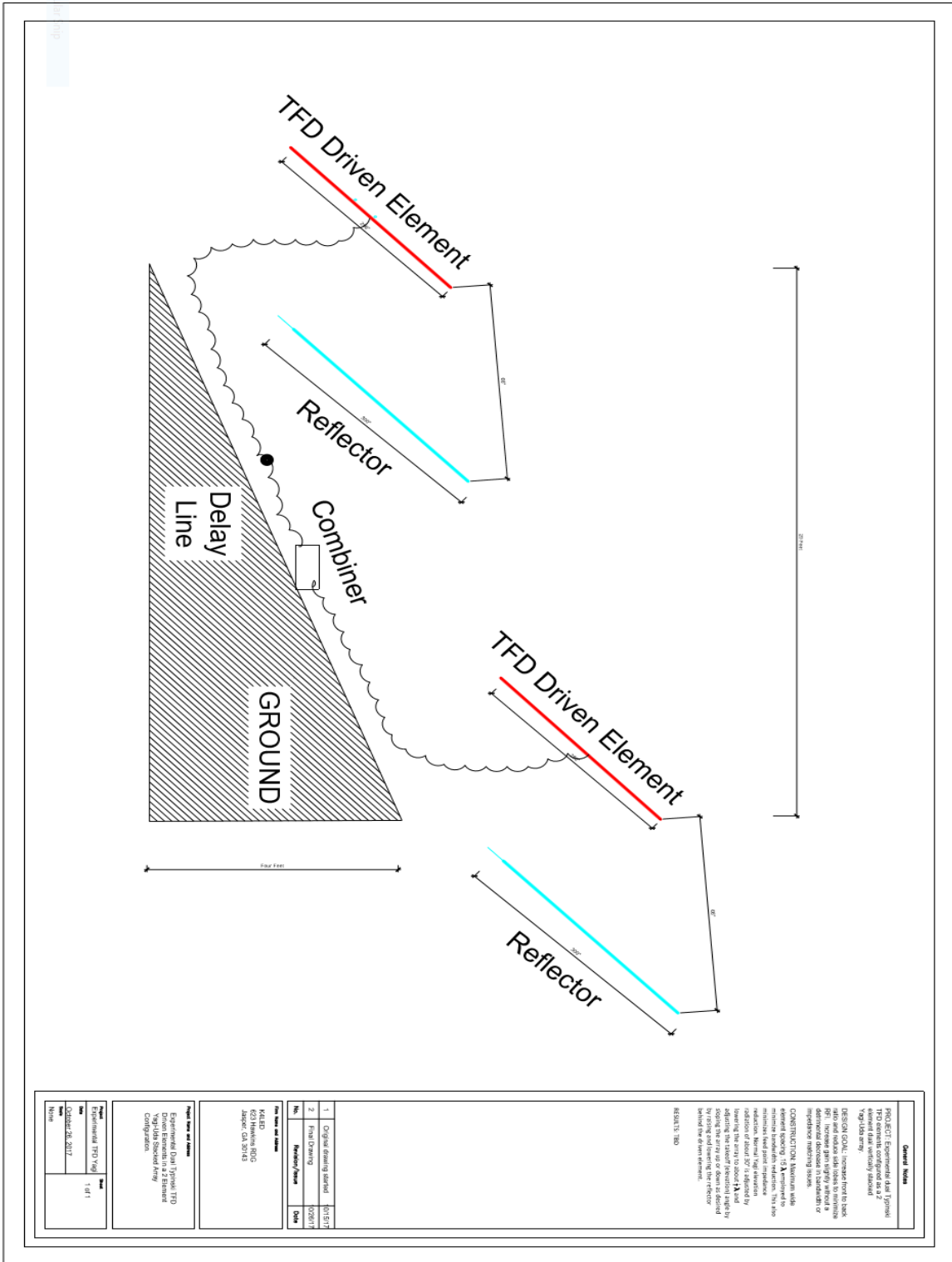

1. Dual TFD Array Modification: Dual Two Element Vertical Stacked Yagi

2. High Frequency Terrain Assessment (HFTA) Version 1.04

This is the terrain in front of the K4LED Observatory TFD 2 Element Yagi Array looking toward the south at 180°. Nothing in front of this location until you get down to the 1,400 foot level.

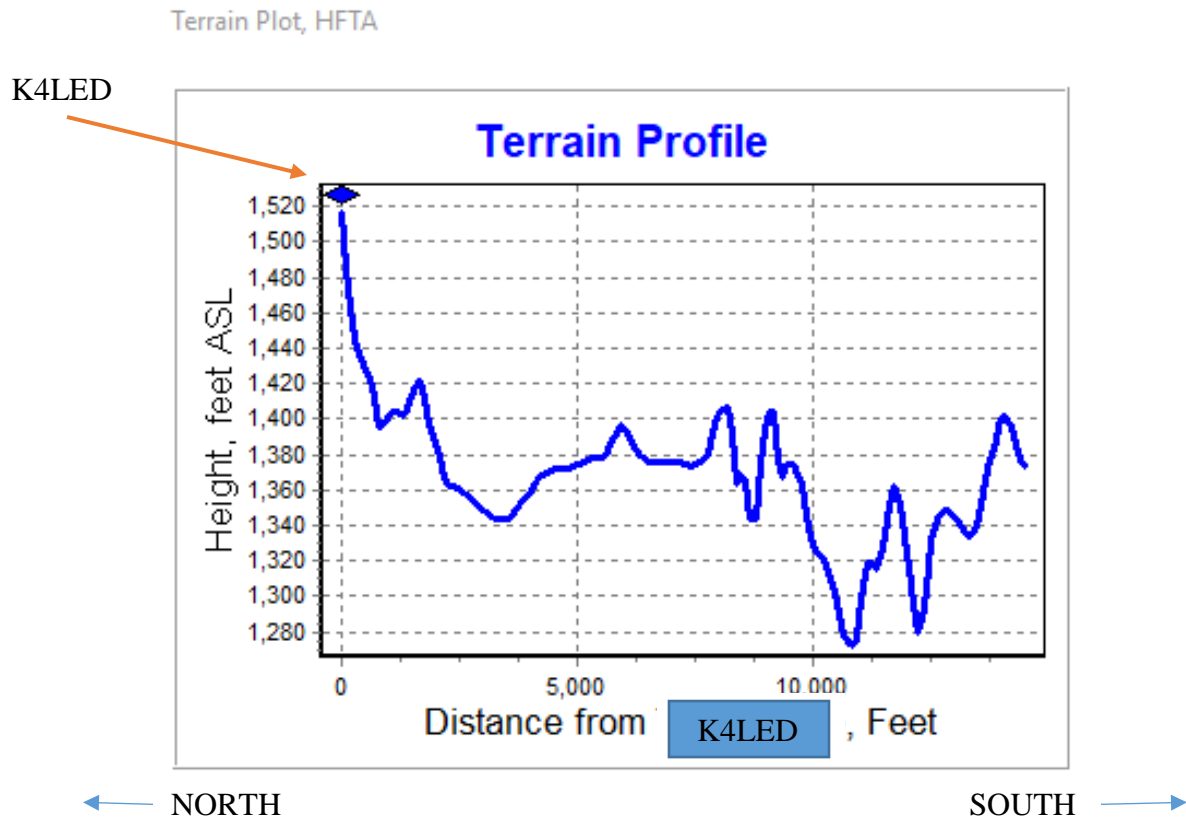

Just for interest below is the terrain looking due North from the K4LED Observatory. The tall peak is Sharp Mountain. You can see K4LED on the south side of Shadow Ridge.

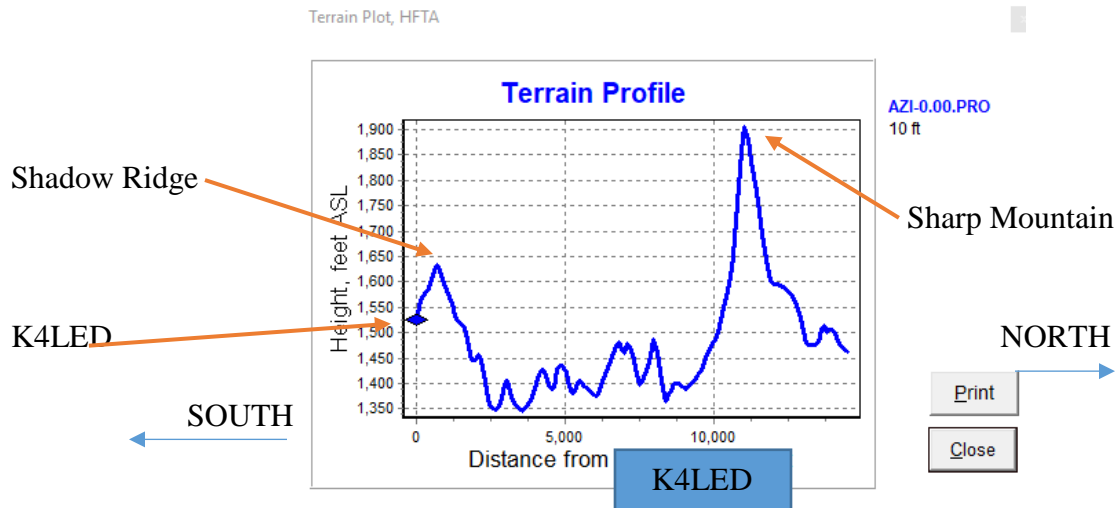

3. VSWR Data.

The VSWR test instrument is a Comet CAA 500 Mark II. The cable loss from the calibration plane to the antenna feed point is 3.1 dB. The measured VSWR at the receiver was below 1.5:1 from 15 to 30 MHz.

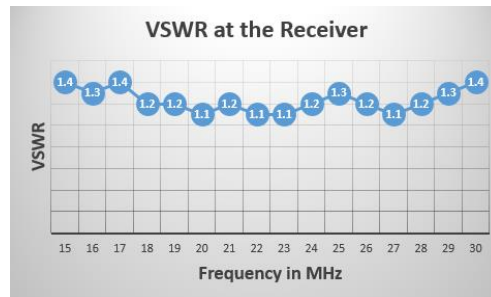
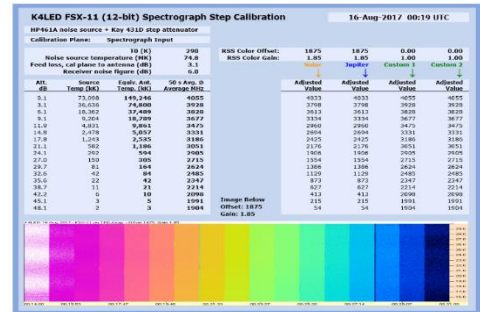
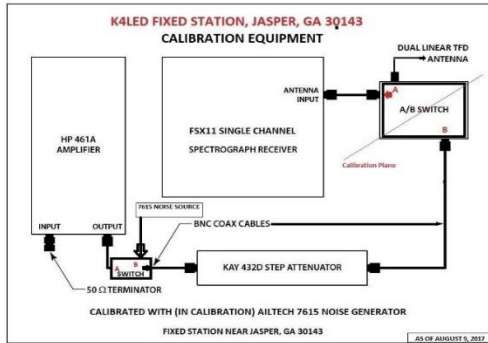

It is important to know that for accurate VSWR the measurements should be made at the antenna feed point. Any cable loss, or attenuation, will make the VSWR at the receiver input end of the cable appear much better than at the antenna feed point. The reason is that the cable loss or attenuation increases the return loss.

$$SWR_{Antenna} = \frac{1 + 10^{\frac{L}{10}} \left(\frac{SWR_{Receiver} - 1}{SWR_{Receiver} + 1} \right)}{1 - 10^{\frac{L}{10}} \left(\frac{SWR_{Receiver} - 1}{SWR_{Receiver} + 1} \right)}$$

where:
L is the cable loss in dB

$$21.4174(.2) = 4.28348$$

$$= 1.103 + 1.5 \text{ dB} = 2.603 \text{ dB}$$

19.4174(.2) = 3.88348
For our maximum receive end VSWR of 1.5 dB and a cable loss of 3.1 dB the VSWR at the antenna feed point is calculated to be 2.6 dB.

